

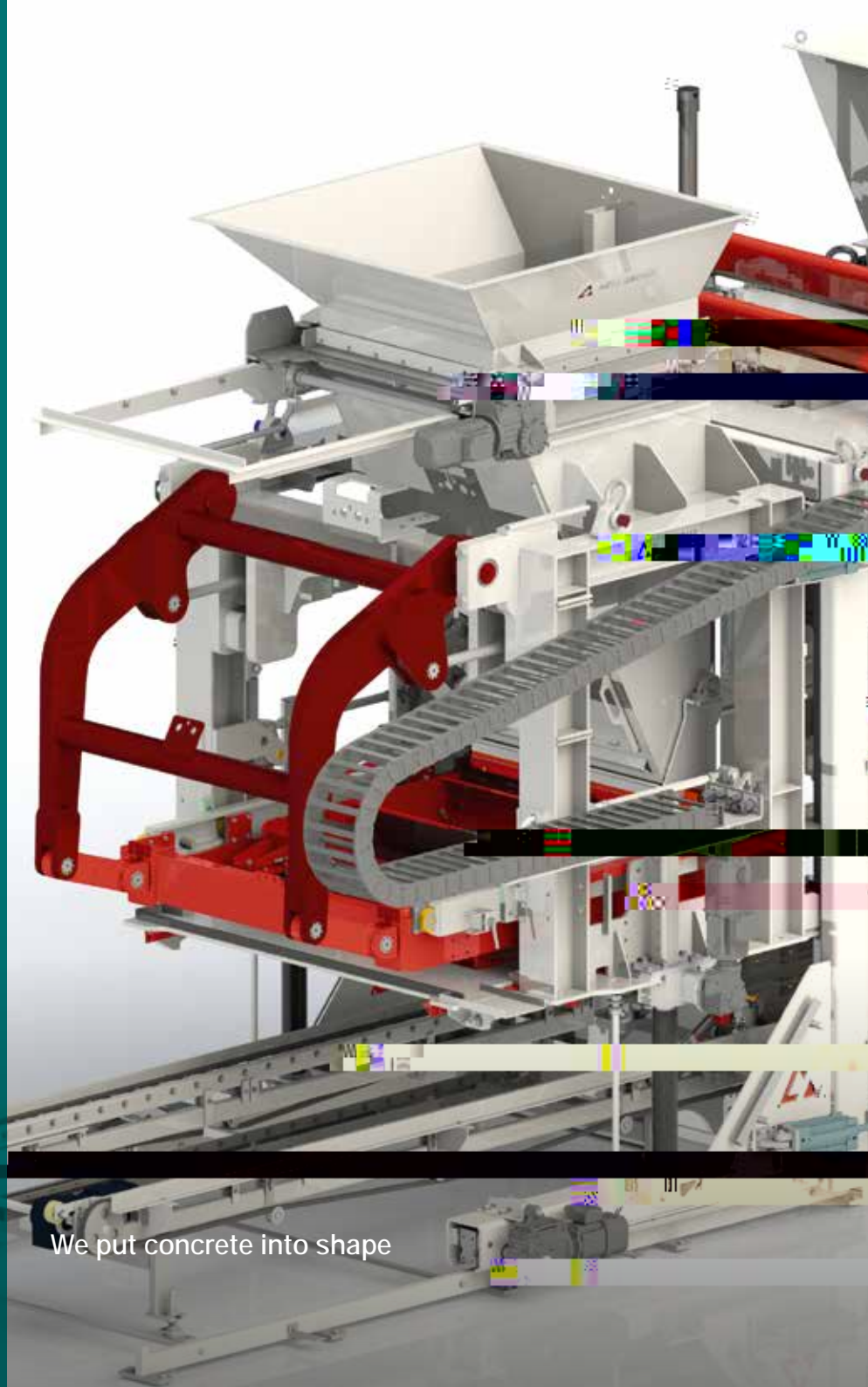

HESS GROUP

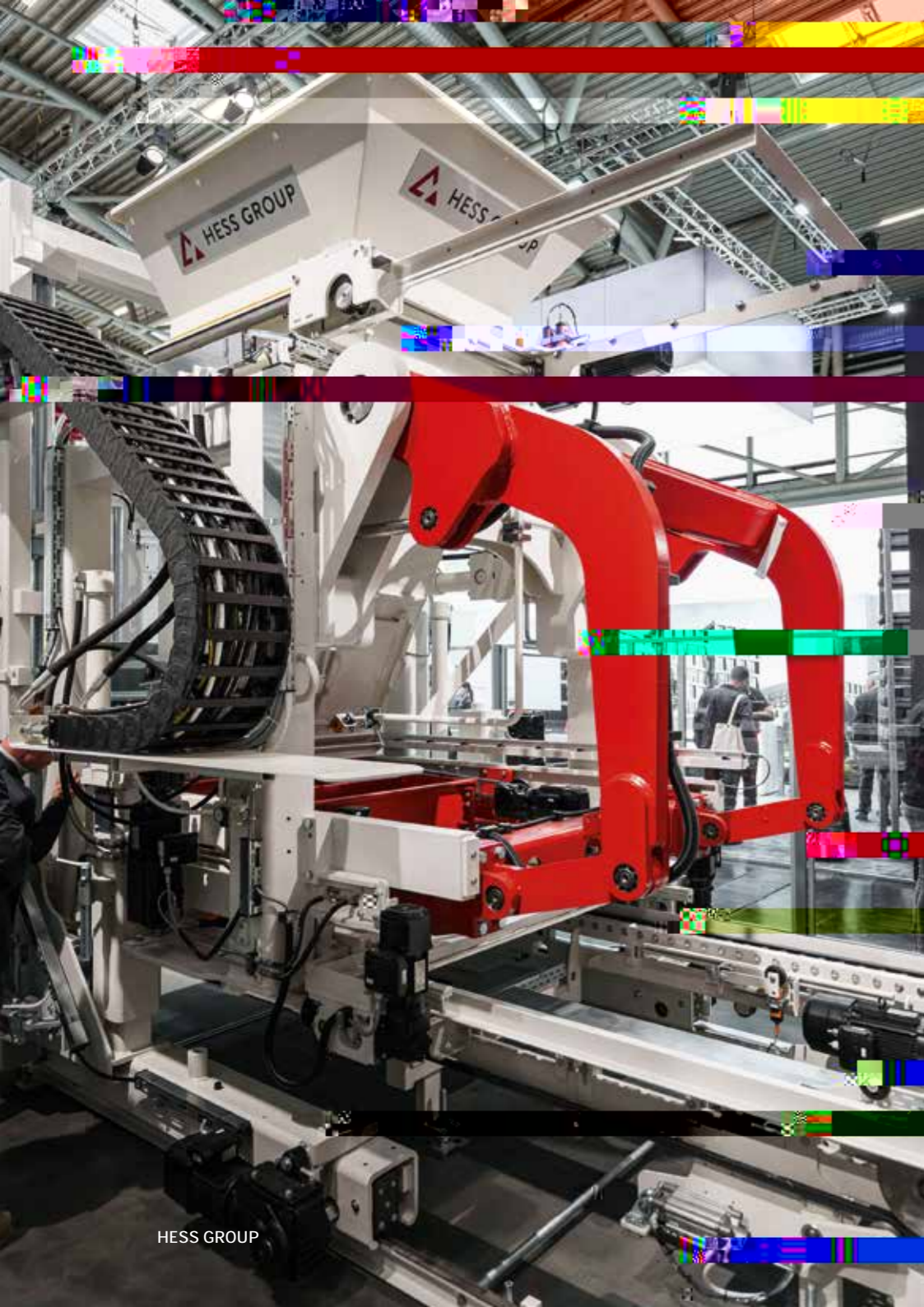



OUR COMPANY

WHO IS HESS GROUP?

MIXERS, HANDLING SYSTEMS,
CONCRETE BLOCK AND PAVER
MACHINES, AND PACKAGING LINES

Our passion is developing technically superior machines for the production, processing, and handling of high-quality concrete products — and we have been doing so since 1948.

As a driver of new sustainable innovations and with a distinctive team spirit in an international environment, we continuously expand HESS GROUP's leading market



As an innovative manufacturer of high-quality concrete block and paver plants, we – together with our customers – ensure our mutual market leadership.

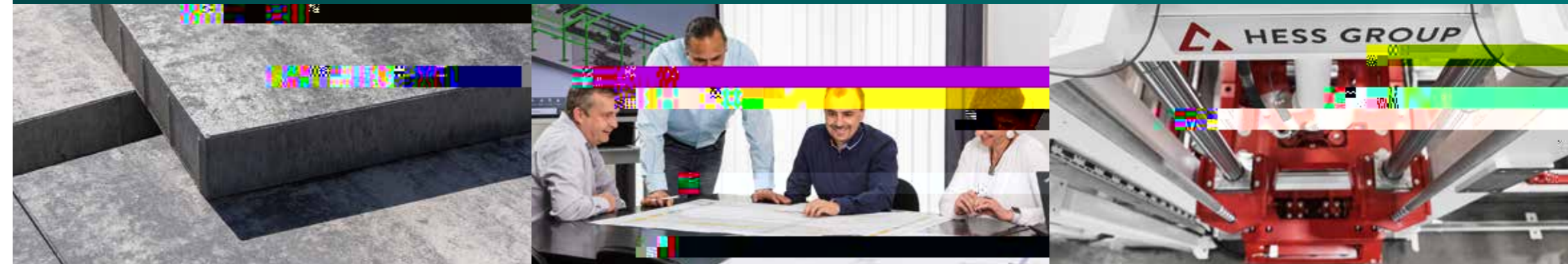

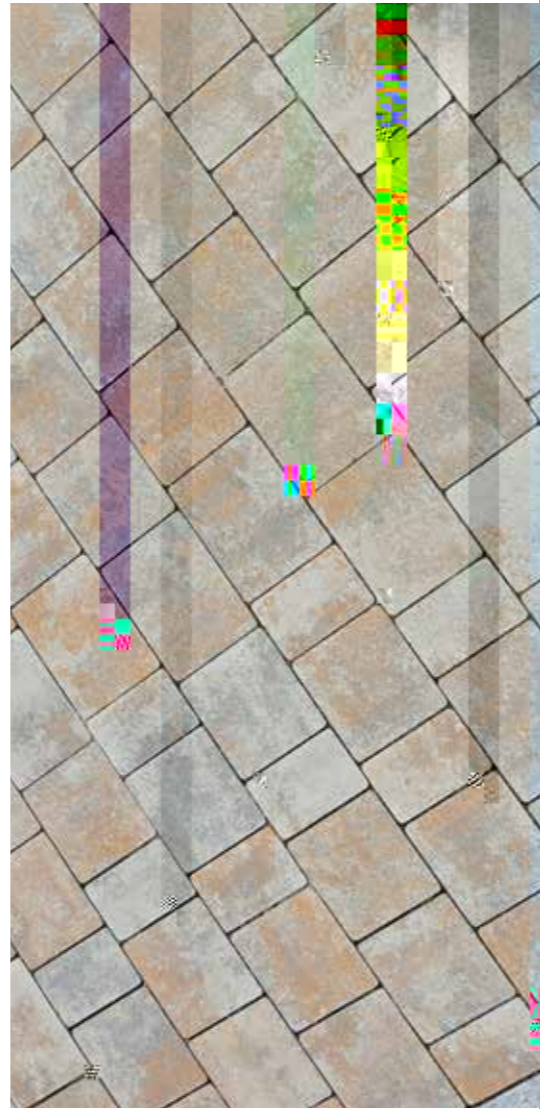
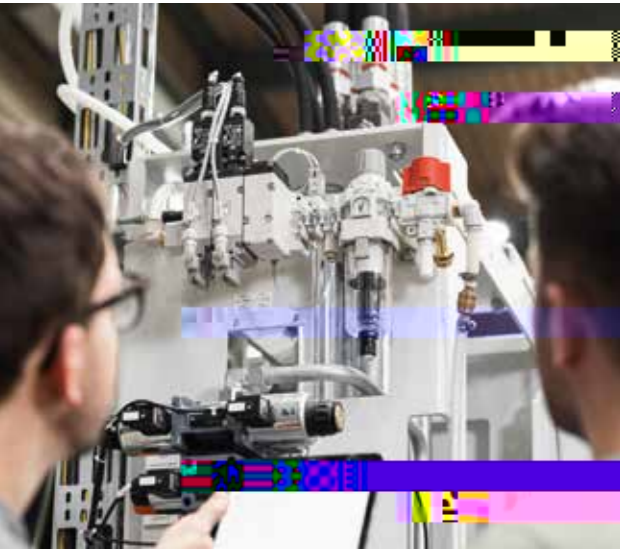

**WE PUT
CONCRETE
INTO SHAPE.**

RH 1450

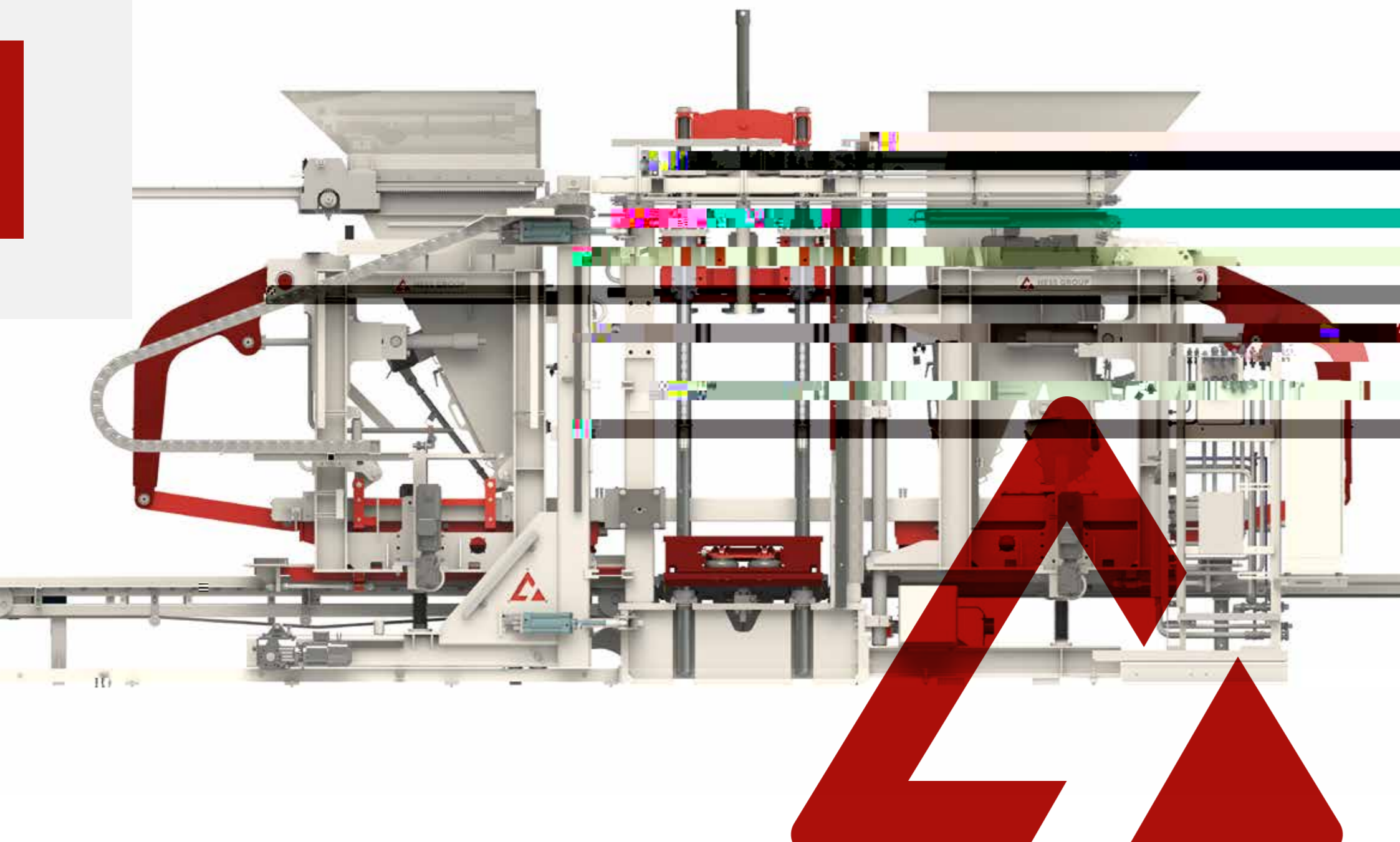

b B+. m[h mi on o ri am]i nm]ch]s qbd b
is achieved through better material utilization and en-
b[h] j lilg[h] (b am]ch]s[ff qmill o]

RH 1450



147.6050 CS B56.69 -12.472 rSCN6S2 gsq8577.212100442.4704 cm577.m2812.677.ISQ8577.8292.442.4704 cm577.m510.7677.ISQ8577.212100

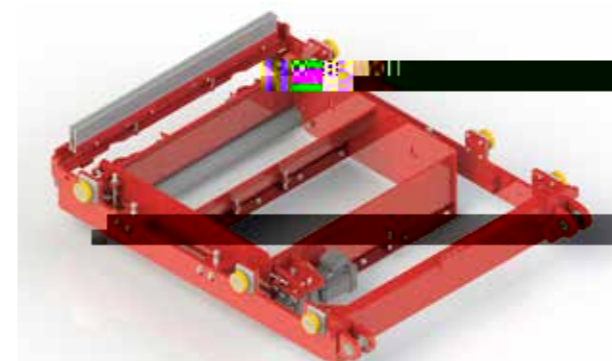
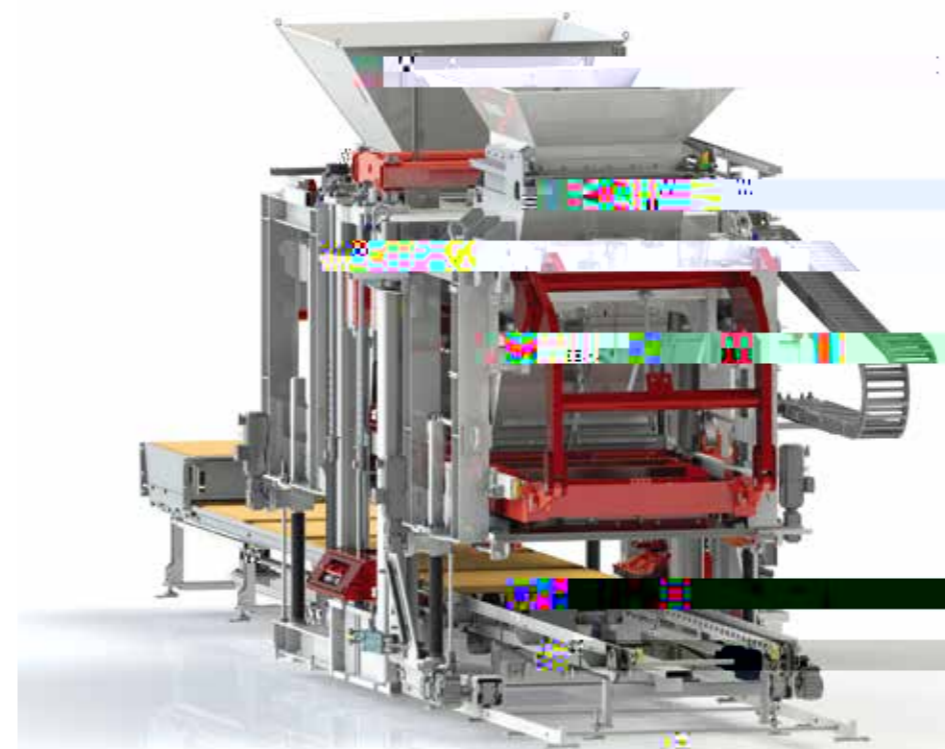

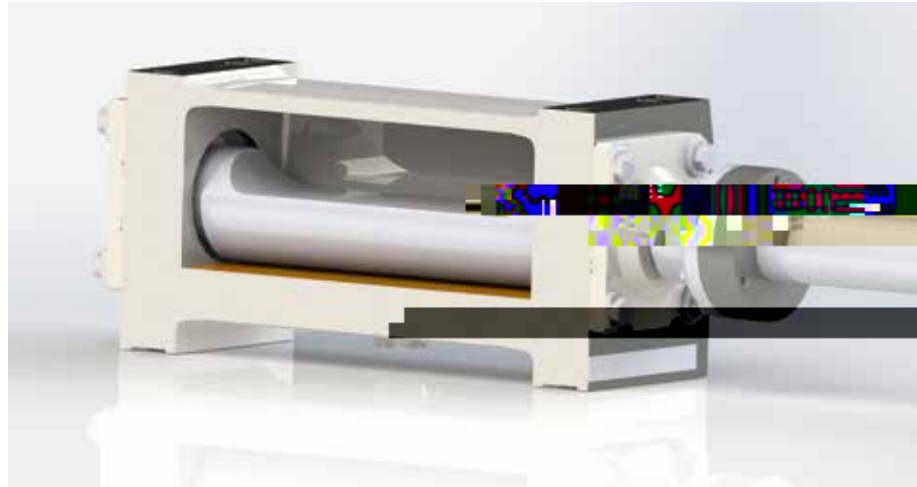

Model oil bath vibrator

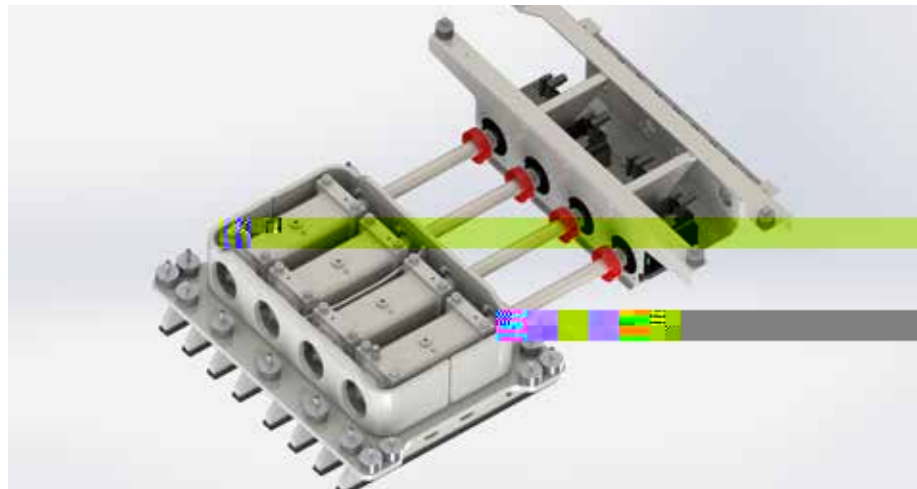

VarioTronic vibrating table, view from below

HESS
**VARIOTRONIC
 WITH OIL BATH VIBRATORS**

FULLY ELECTRIC CONTROL



Colormix device with draw plate



Colormix device with two layers of colored concrete

HESS
COLORMIX DRAW PLATE

MANUFACTURING MULTICOLORED CONCRETE PRODUCTS

- i nm] chnq[s ri g [ho [] nol
 multicolored concrete products.
- Can be used on both face and base concrete hoppers.
- Adjustable parameters at the control panel

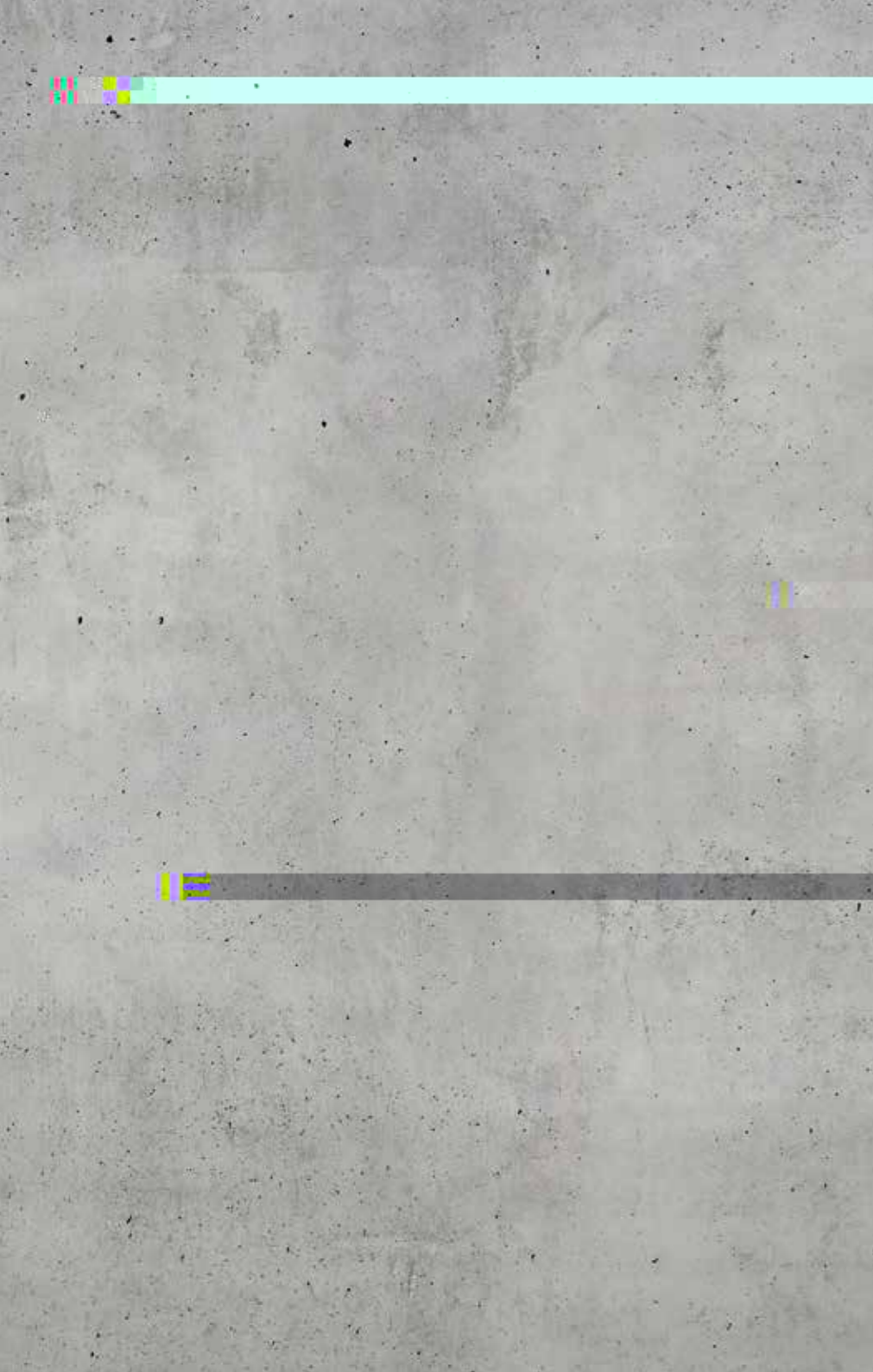

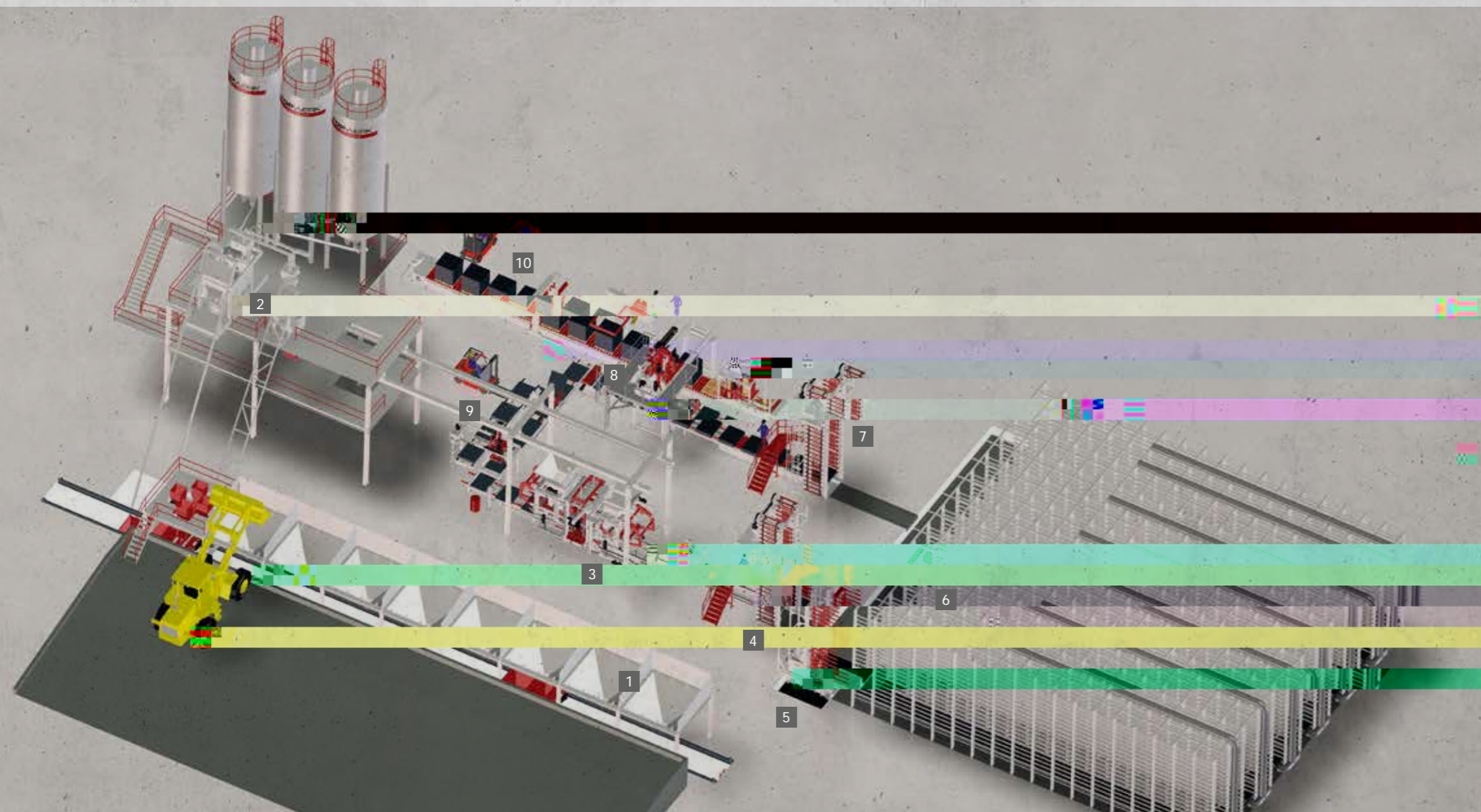

RH 1450 VA	
1	Aggregate silos
2	Mixing plant
3	Block and paver machine RH 1450 VA
4	Elevator
5	Finger car
6	Curing racks
7	Lowerator
8	Cuber Servo 700-2
9	Production board displacer with buffer conveyor
10	Frame conveyor with I frames

HESS

COMPLETE SYSTEMS

CUSTOMIZED
MARKET-ORIENTED
OPTIMIZED FOR THE CUSTOMER

HESS develops, together with the customers, system concepts that are tailored to the respective requirements.

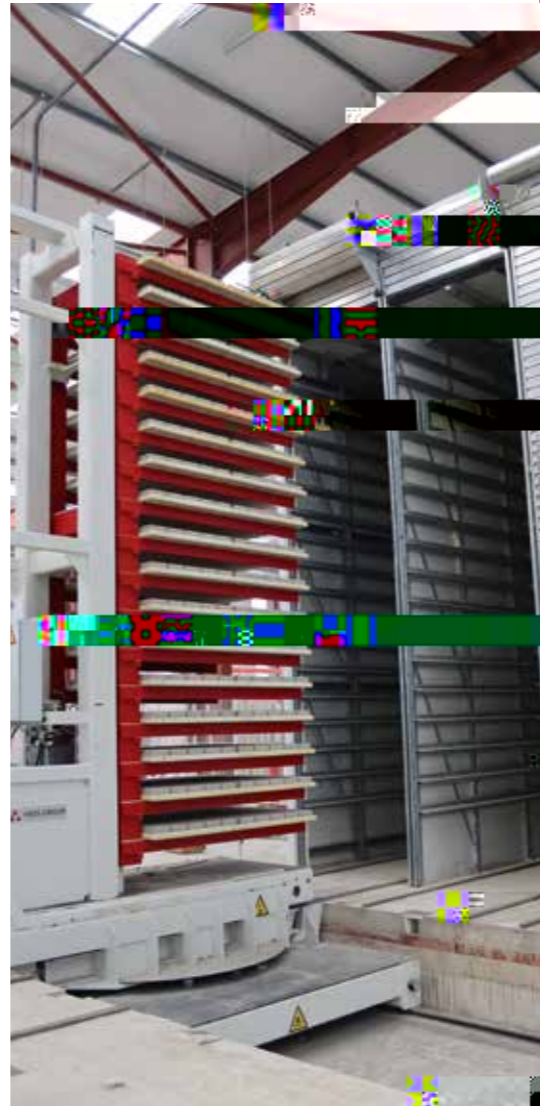
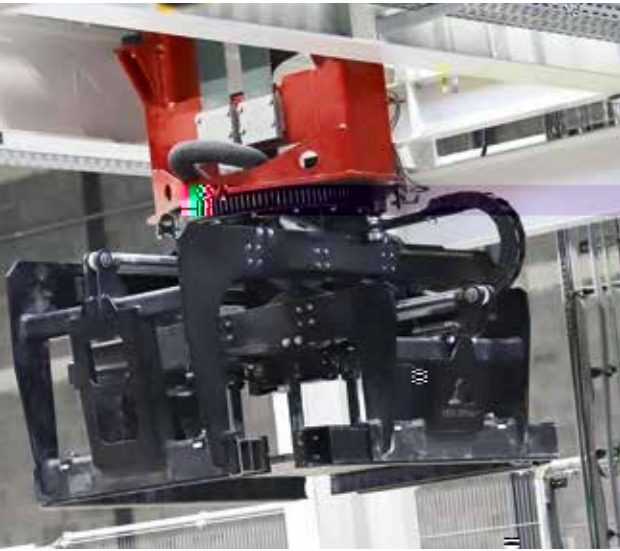

**WE PUT
CONCRETE
INTO SHAPE.**

**BATCHING AND
MIXING PLANTS,
CONVEYING AND
HANDLING SYSTEMS**



HESS

BATCHING AND MIXING PLANTS

For the production of high-quality concrete products (interlocking paving stones and slabs, curbstones, hollow blocks and segmental retaining walls, pipes and man-holes as well as various precast elements), we offer the necessary mixing plants including all batching devices for aggregates, cement, and Color-Mix concrete.

HESS GROUP



Interior view of mixer with raw materials

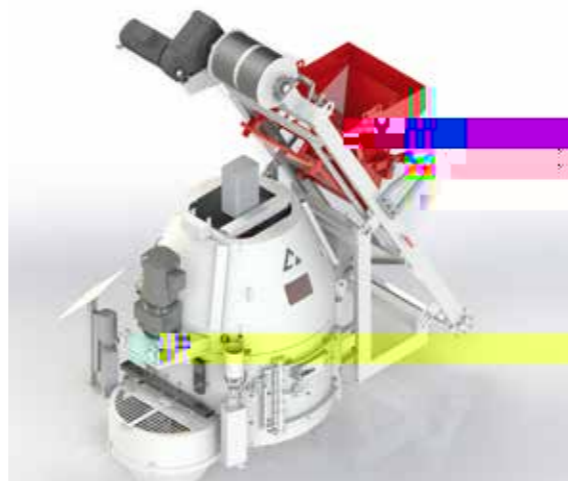

Face concrete mixer SM 500

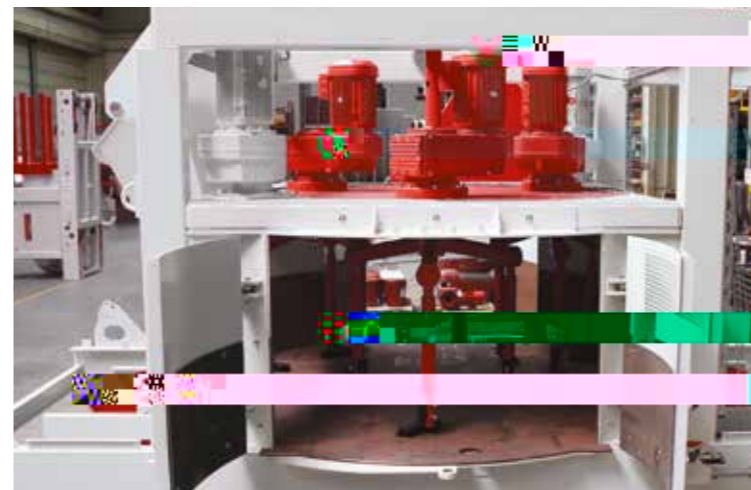

Interior view of base mix mixer



Color-Mix shuttle belt system

TECHNICAL OVERVIEW OF BATCHING AND MIXING PLANTS*

	SM 500	SM 1500	SM 2250	SM 3375	SM 4500
Capacity [kg]	500	1,500	2,250	3,375	4,500
Capacity [l]	800	2,400	3,600	5,400	7,200
Compacted concrete output per batch [m ³]	0.333	1	1.5	2.25	3
Main drive [kW]	15	22	30	2 x 22	3 x 22
Number of star drives and agitator [pcs]	1+1	2	2	3	3
Drive skip hoist [kW]	7.5	18.5	18.5	22	30

* Technical Data are subject to change.

FEATURES OF PLANETARY MIXER SERIES SM

- Self-supporting construction with lower and upper frame
- Separate drive system (for tool mounting plate and mixing stars)
- Stopping and starting the fully loaded mixer at any time possible
- Two large opposite doors for unobstructed cleaning and maintenance
- Two large discharge openings in the floor
- Machine with high cleaning effort due to special water supply
- Optionally, for cement feeding to the mixer an auger is available (almost dust-free cement feeding)
- Because of its high mixing intensity, this method is particularly suitable for producing concrete with a low water-cement ratio.



Color-Mix Product

HESS GROUP

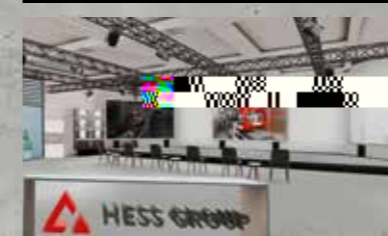
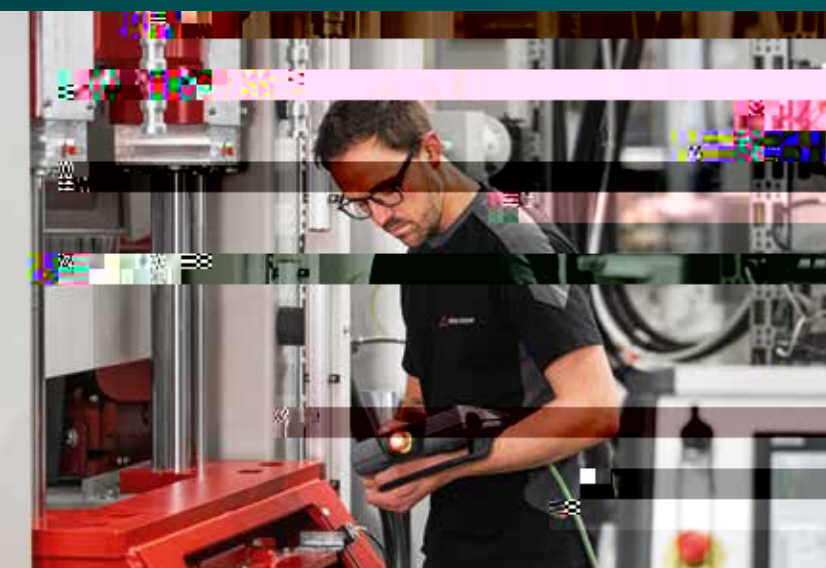



HESS Group GmbH

Freier-Grund-Strasse 123
57299 Burbach-Wahlbach, Germany

Phone: +49 31-0 310
Fax: +49 31-0 310
www.hessgroup.com

We put concrete into shape