

B E E

CC

E & I

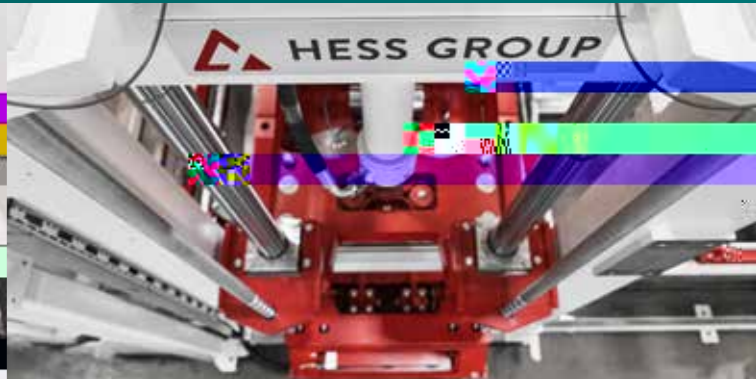

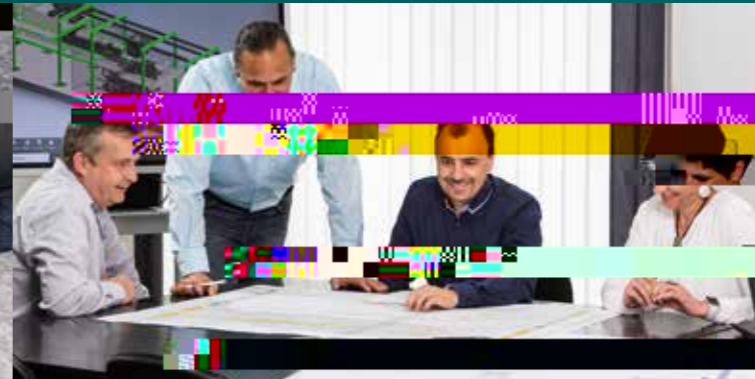
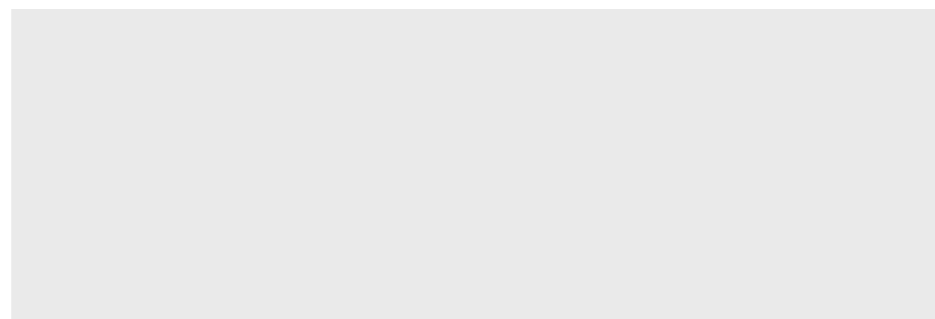
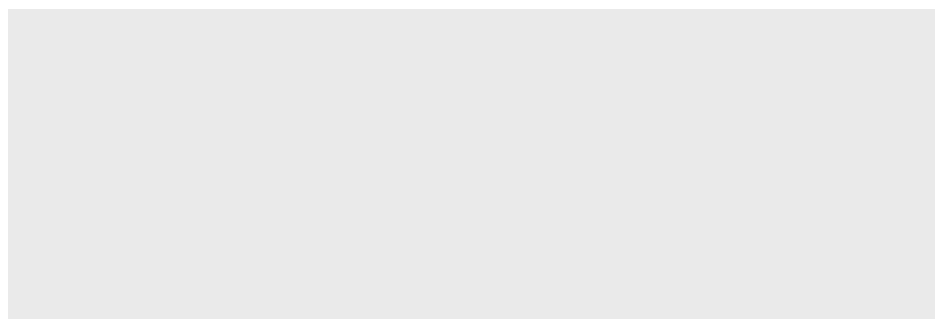
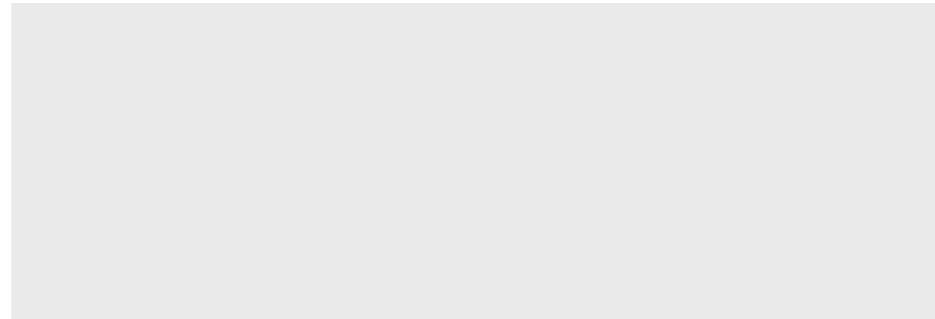
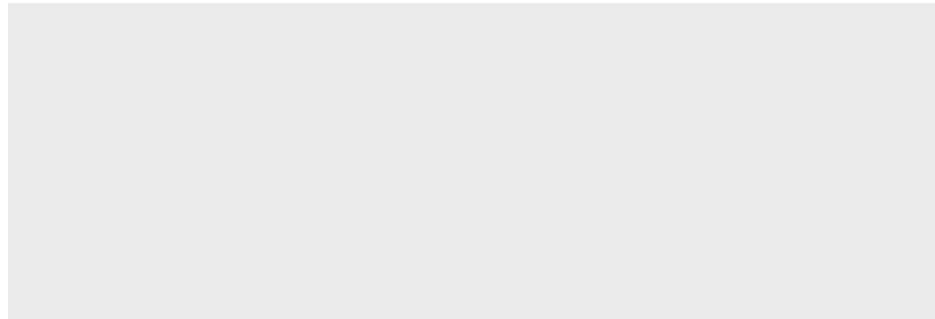
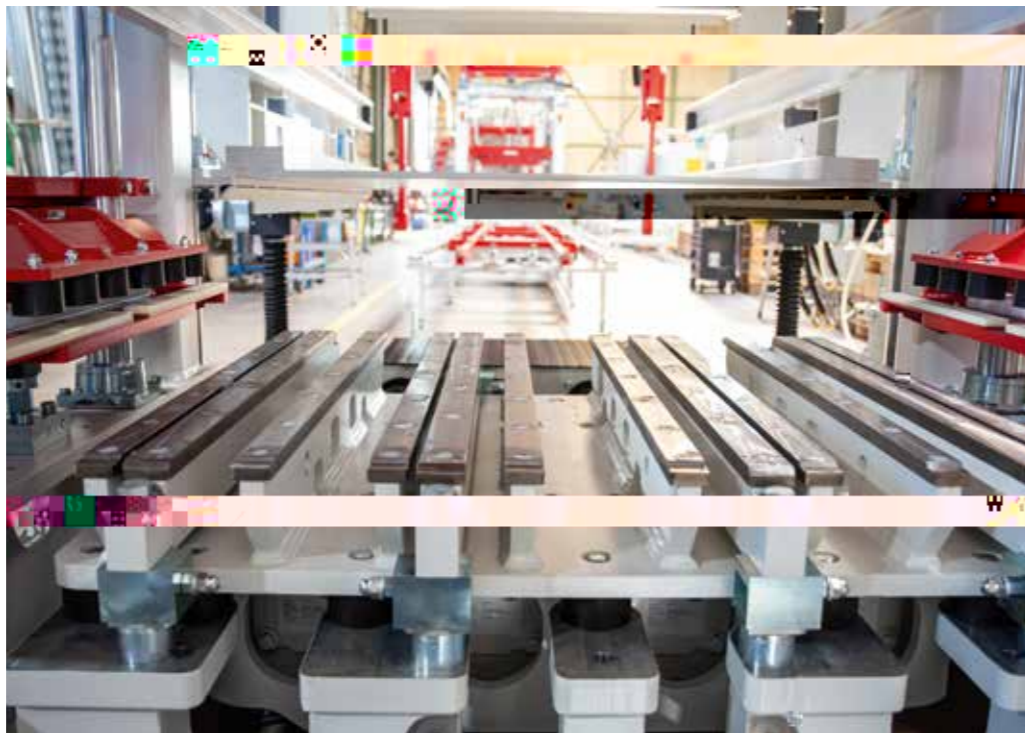
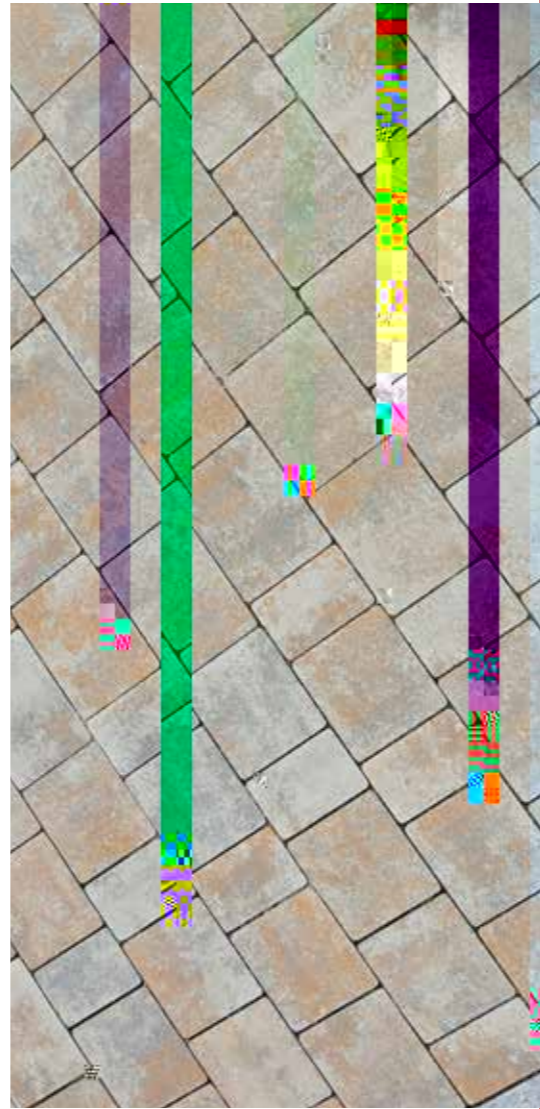
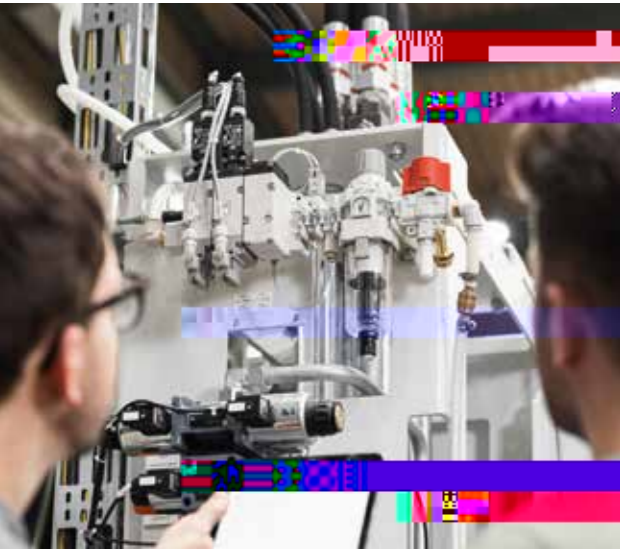

IP E

RH 1450



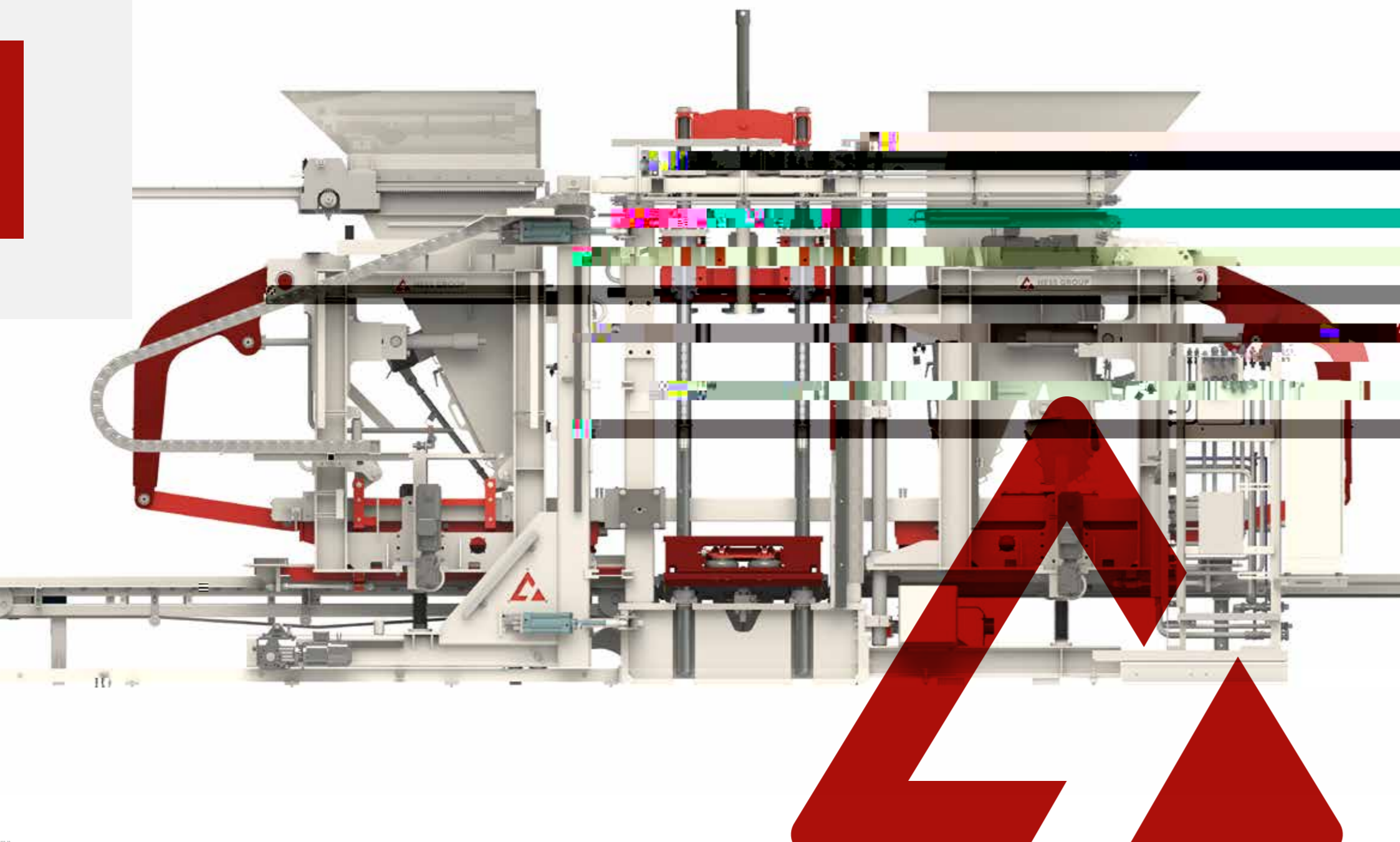

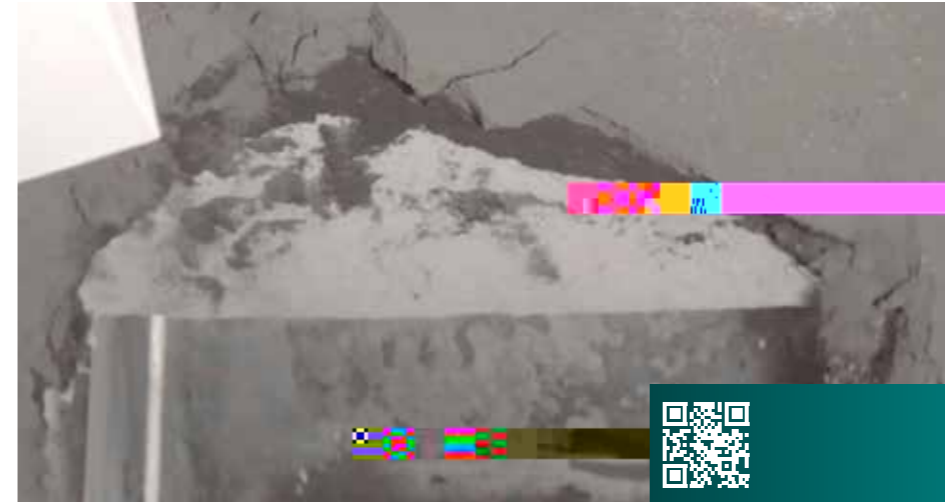
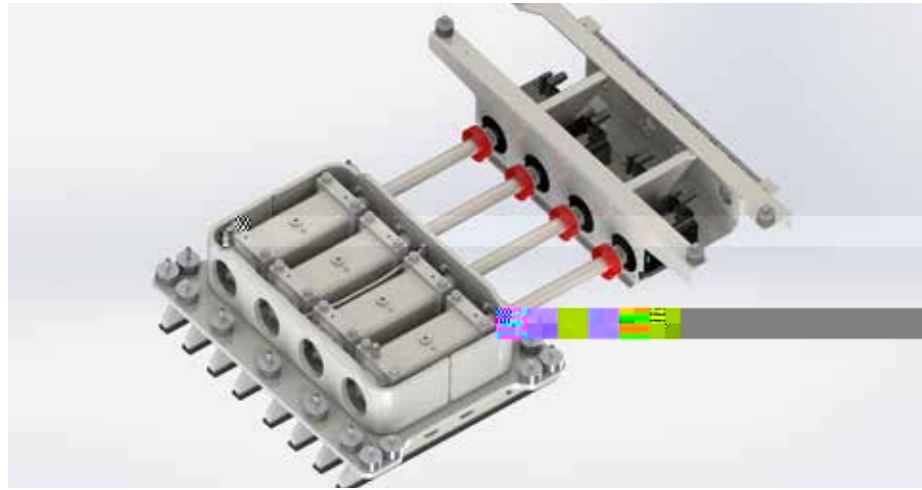
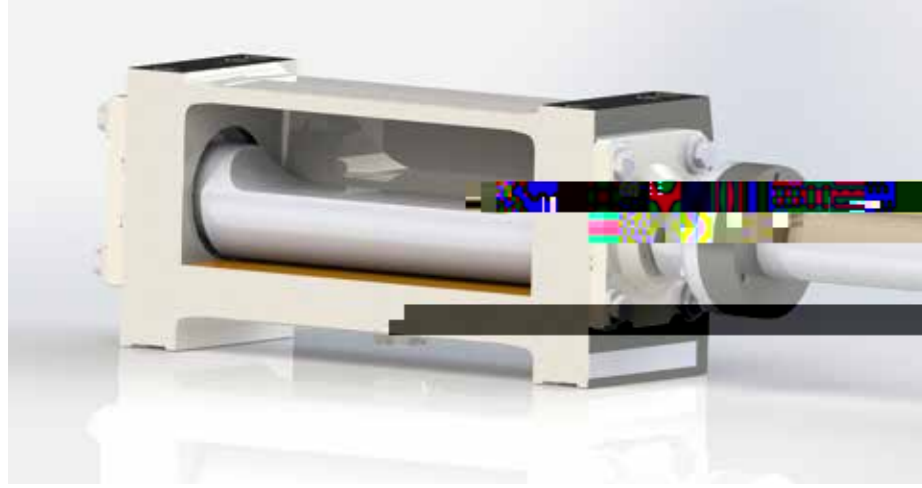



☞ ☞-IE IP ВЛЕ E

A large grid of grey and white squares, resembling a data table or a grid. The grid is composed of approximately 10 columns and 15 rows of squares. The squares are arranged in a regular pattern, with some squares being a lighter shade of grey than others.

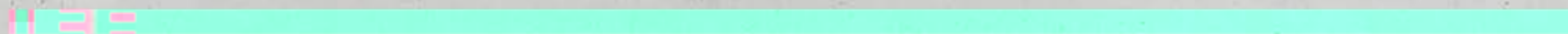



СЕРИЯ
ЦЕЛЬ
ОБЪЕКТ

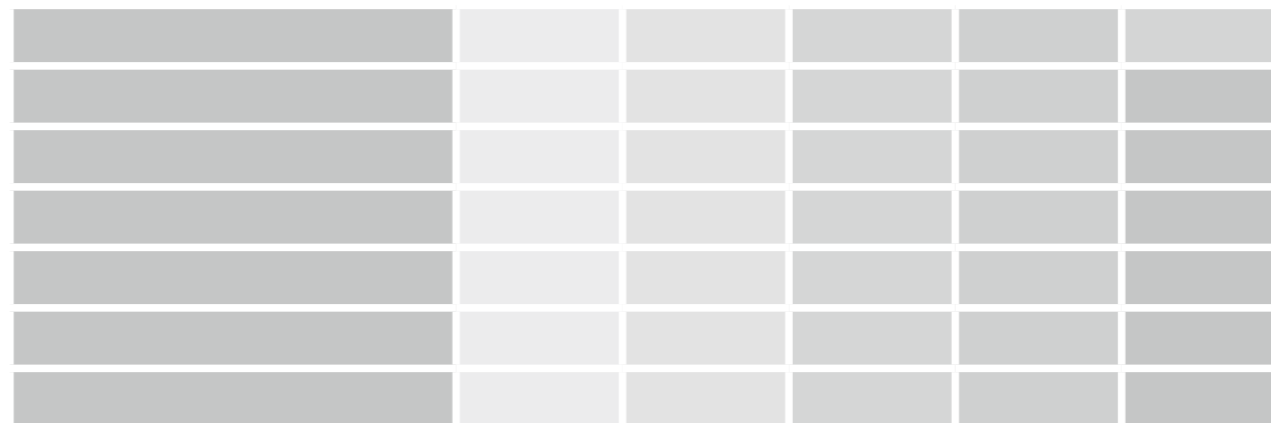
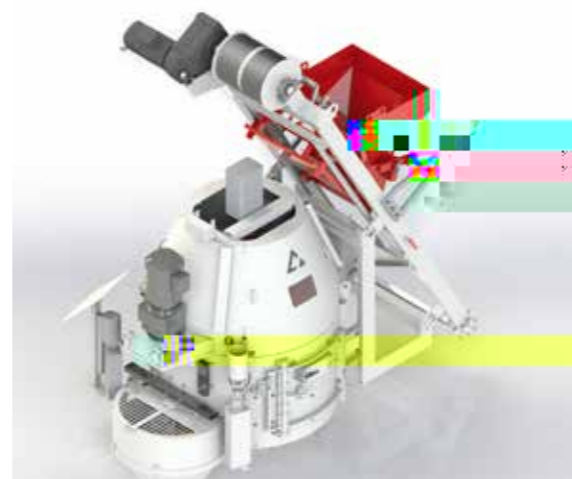
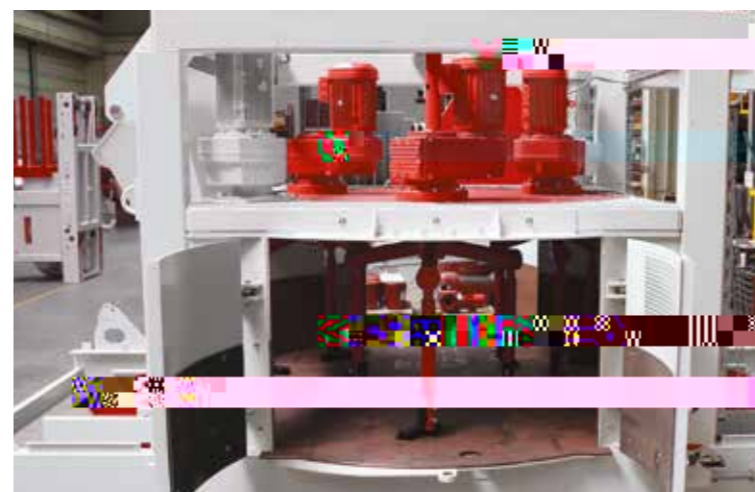

-
-
-
-
-
-
-
-
-
-



